

JAREK 1D

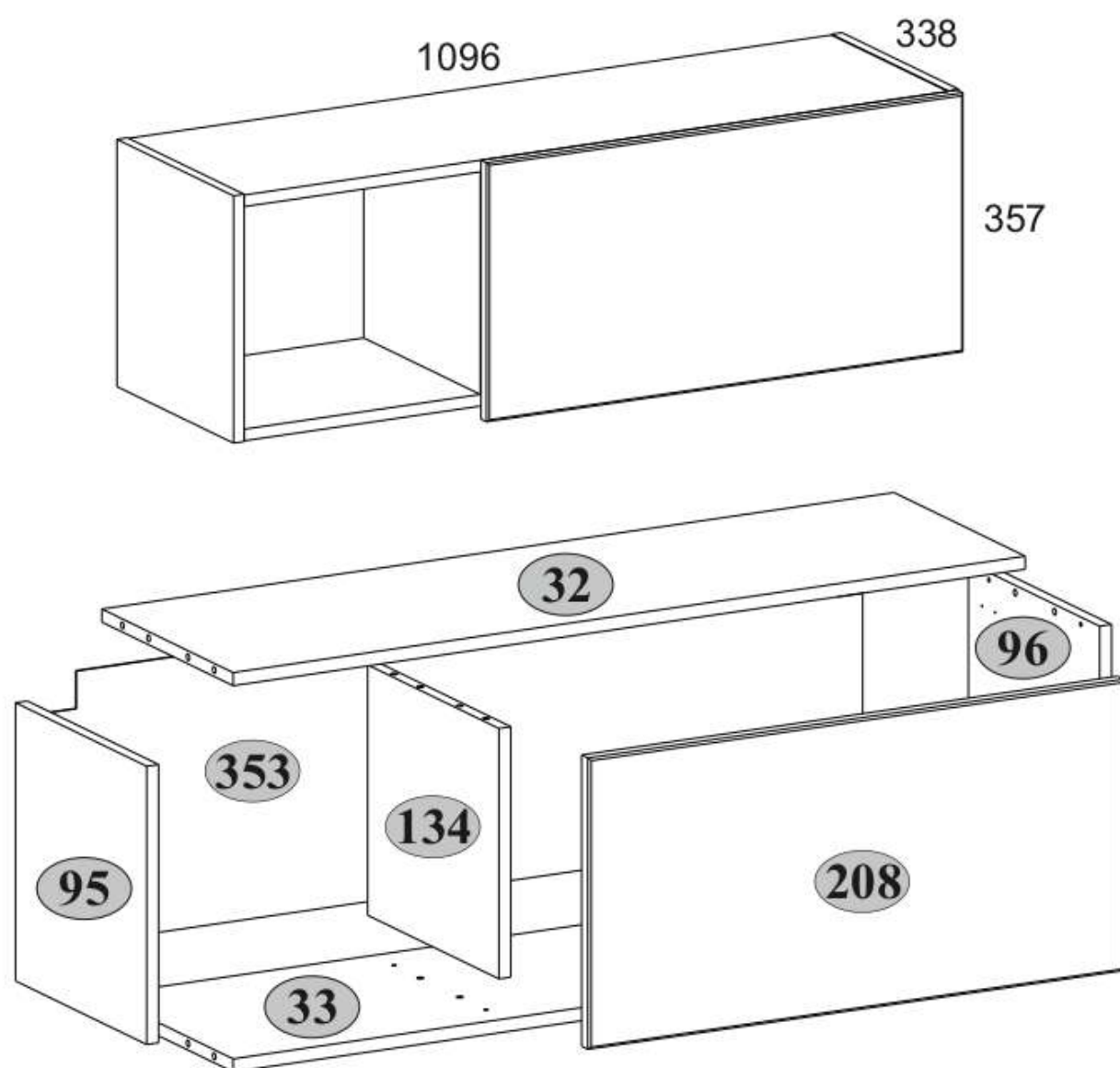

ŠTEVILO	DOLŽINA	ŠIRINA	GLOBINA	ŠTEVILO KOSOV	PAKI-RANJE
32	1064	320	16	1	1/1
33	1064	320	16	1	1/1
95	340	320	16	1	1/1
96	340	320	16	1	1/1
134	306	320	16	1	1/1
208	720	356	18	1	1/1
353	334	1092	2,5	1	1/1

Navodila za uporabo

Priporočljivo je, da ob nakupu razpakiranega izdelka v trgovini preverite njegovo kakovost in popolnost. Izdelek je treba sestaviti tako, kot je opisano v tem priročniku.

Medtem ko je izdelek v uporabi, je treba občasno zategniti ohlapne vijačne spoje.

Če je treba premikati predmete po stanovanju, morate pred premikanjem izdelek popolnoma sprostiti z bremena (ležišča). Da bi preprečili poškodbe obstoječih nosilcev, je treba izdelek pred premikanjem dvigniti. Pohištvo ne sme biti izpostavljeno stiku z vodo.

Brisanje prahu na izdelku je treba opraviti z rahlo vlažno mehko krpo.

Da bi preprečili deformacijo delov in spremembo barve izdelkov, pohištva ne nameščajte na neposredno sončno svetlobo.

Medtem ko je izdelek v uporabi, je **PREPOVEDANO**:









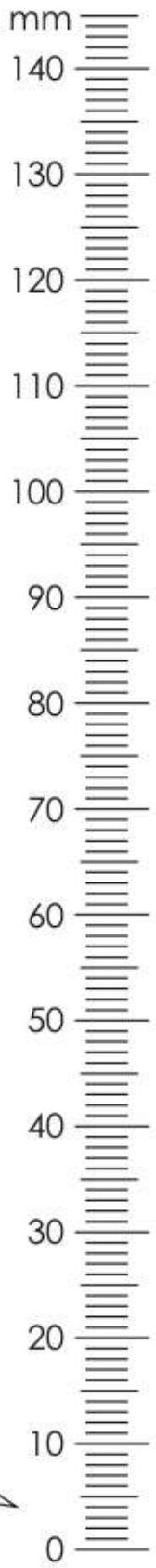



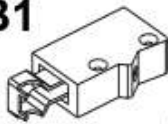

- nameščati pohištvo v bližini grelnih naprav, blizu surovih sten in v prostorih z relativno vlažnostjo več kot 70 %;
- segrevati elementov pohištva na temperaturo, višjo od 40 C;
- med sestavljanjem in uporabo kompleta izdelkov stopati na vodoravne ščite in okna;
- uporabljati kemičnih čistil za čiščenje pohištva.

Garancija proizvajalca

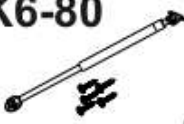
1. Garancijski rok za uporabo izdelka - 18 mesecev od datuma prodaje. V garancijskem roku proizvajalec zagotavlja popravilo ali zamenjavo izdelkov, če uporabnik ni kršil pravil uporabe.
2. Reklamacije mora potrošnik vložiti neposredno pri trgovski organizaciji, v kateri je bilo pohištvo kupljeno, pri čemer mora predložiti "Navodila za uporabo " in kopijo potrdila o prodaji.
3. Izdelek, ki je del kompleta, izpolnjuje zahteve državni standardi 16371-2014, TR TS 025/2012.
4. Življenjska doba pohištva - 5 let.
5. Proizvajalec si pridržuje pravico do sprememb v zasnovi izdelka, ne da bi pri tem ogrozil njegove zahteve glede zasnove in uporabe.
6. Za sestavljanje izdelkov je priporočljivo vključiti usposobljeno osebje.

To je pomembno! Navodila shranite za primer ponovne montaže pohištva ali reklamacije. Pri uveljavljanju reklamacije uporabite zapis iz navodila.



A1  12	A2  12	B1  2
B5  10x50 2	C1  8x35 12	D1  2
E1  2	G  1,5x26 30	K6-80  2
Q  2	R10  4x30 4	R23  6,3x13 4
R102  3,5x16 4	S5  12	

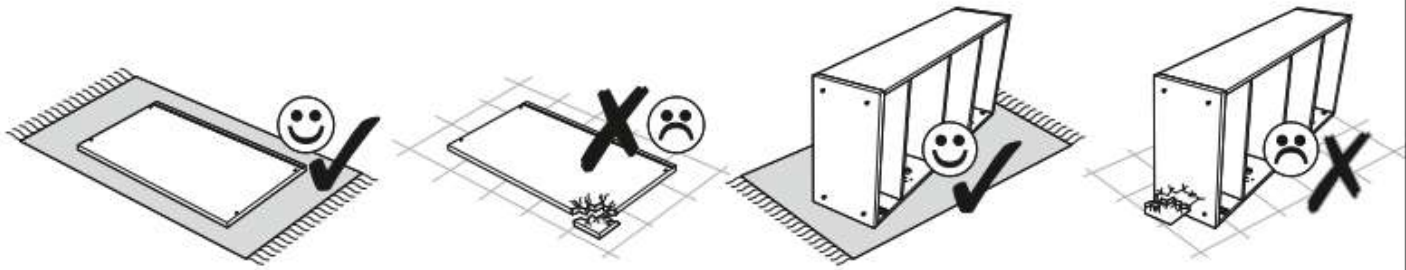
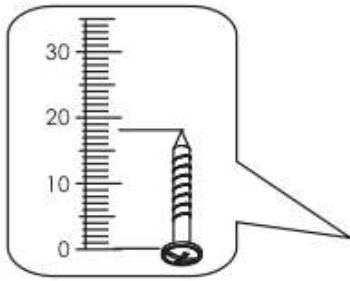
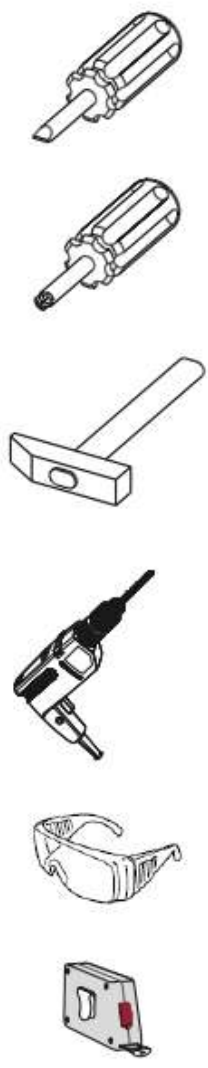

1

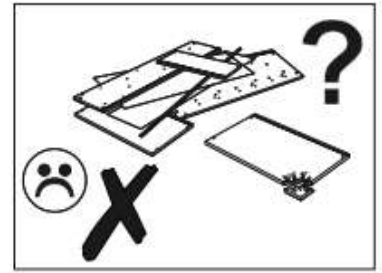
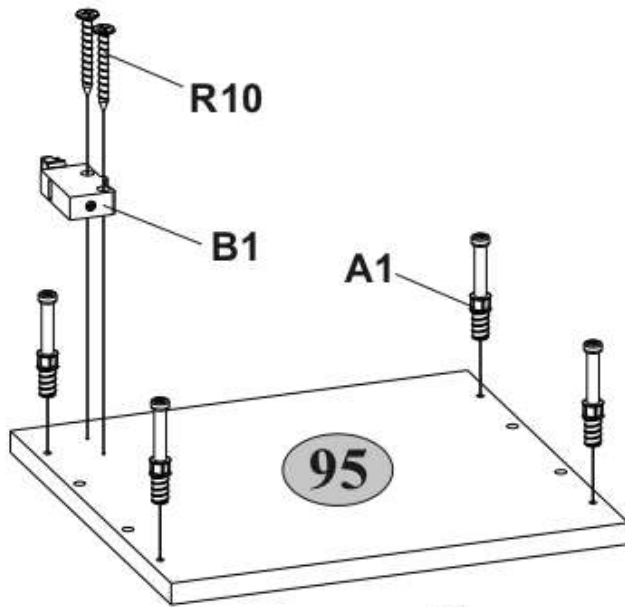

2

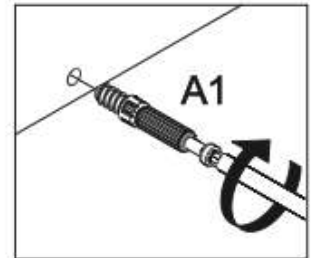
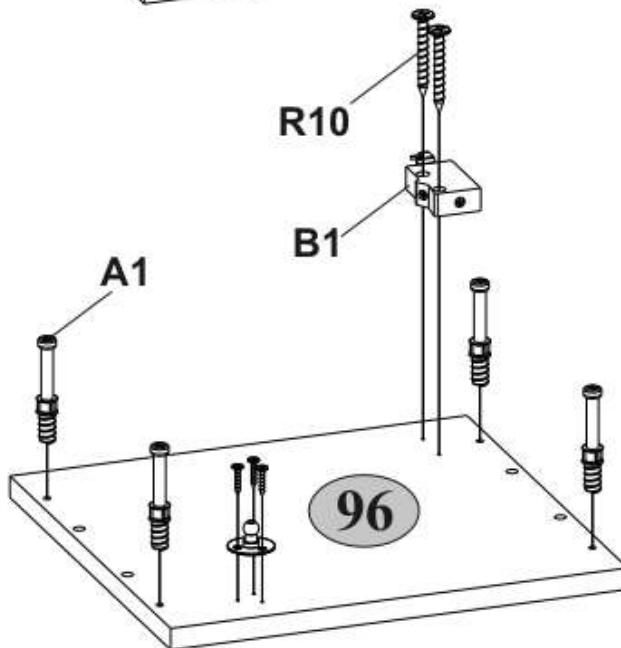

3

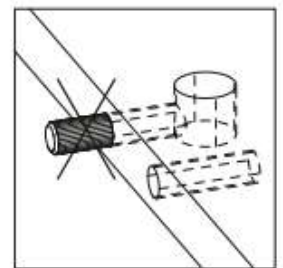
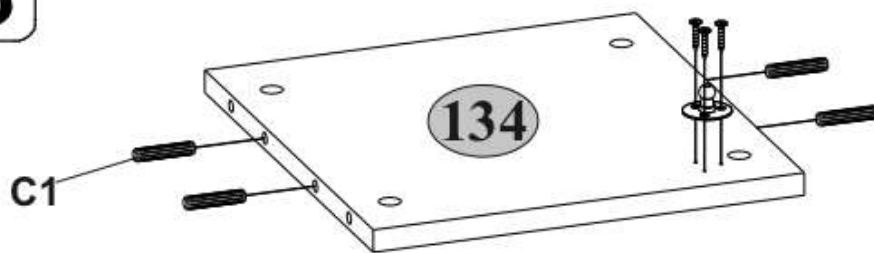

4

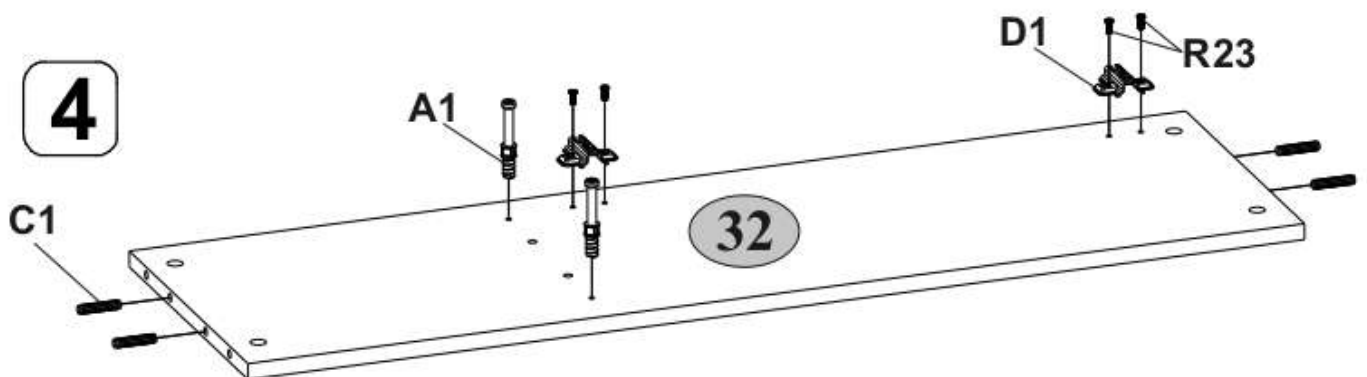

5

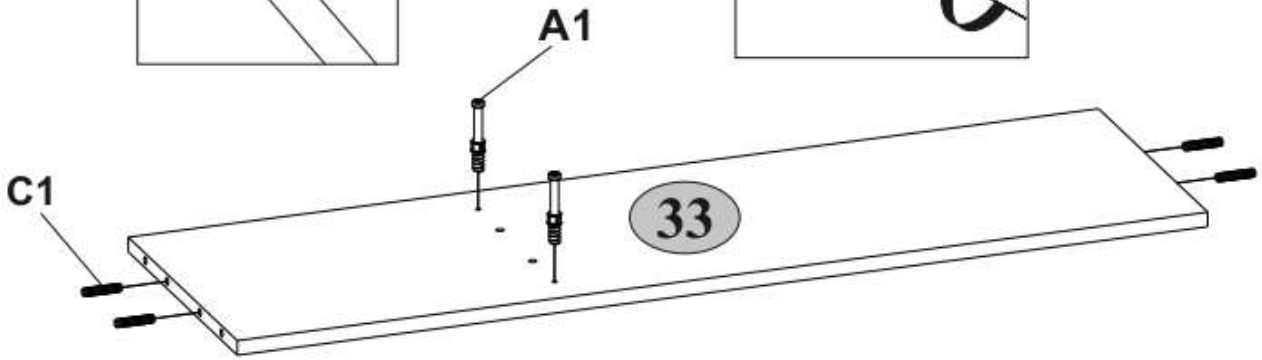
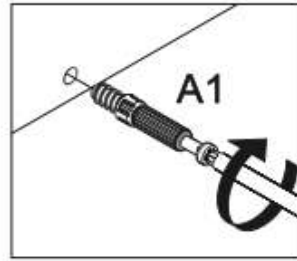
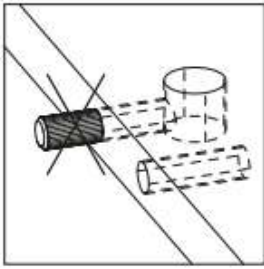

6

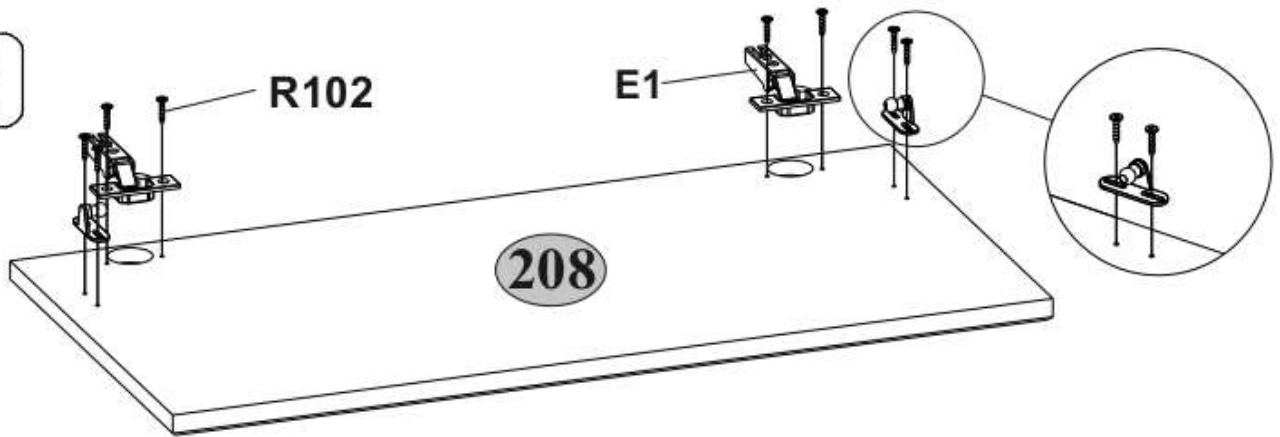

7

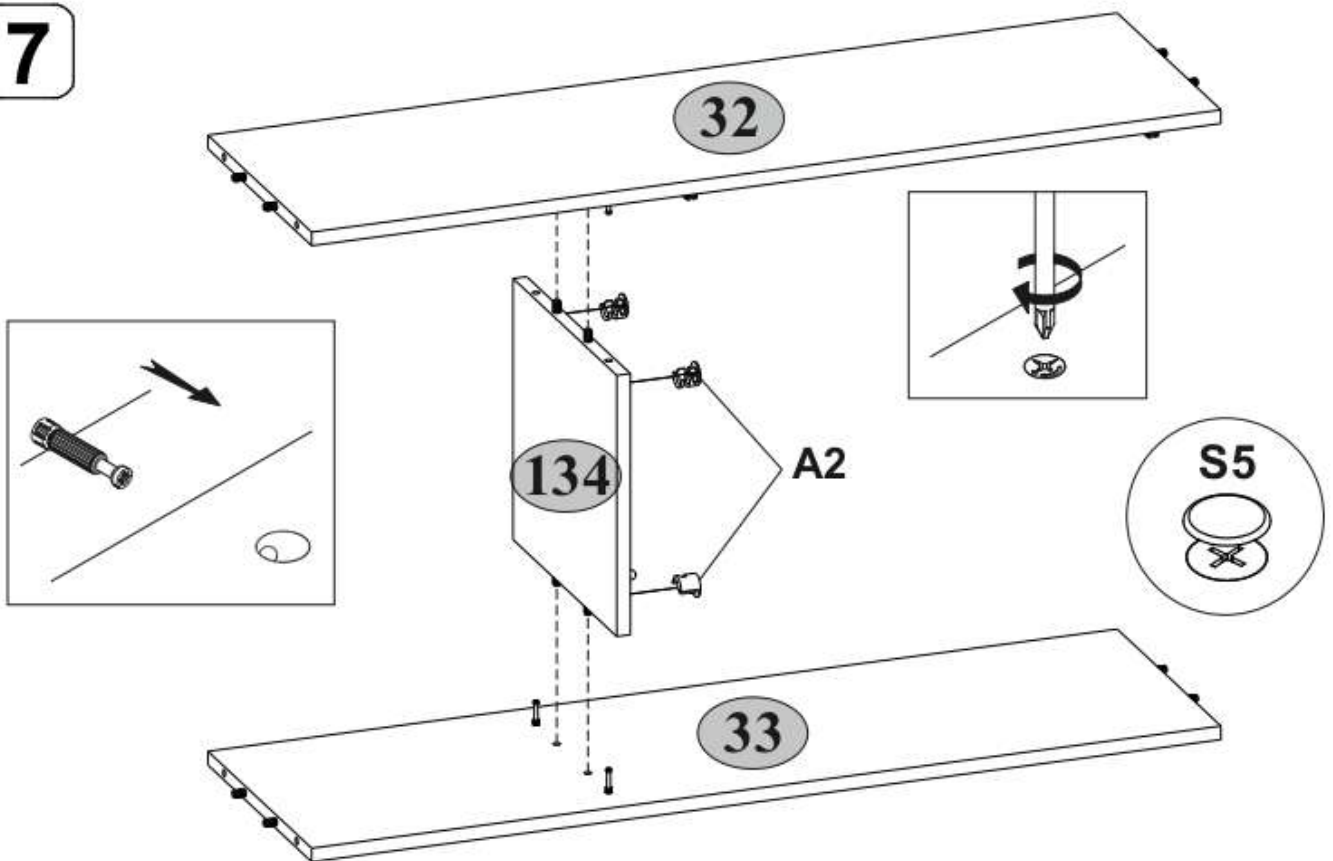

8

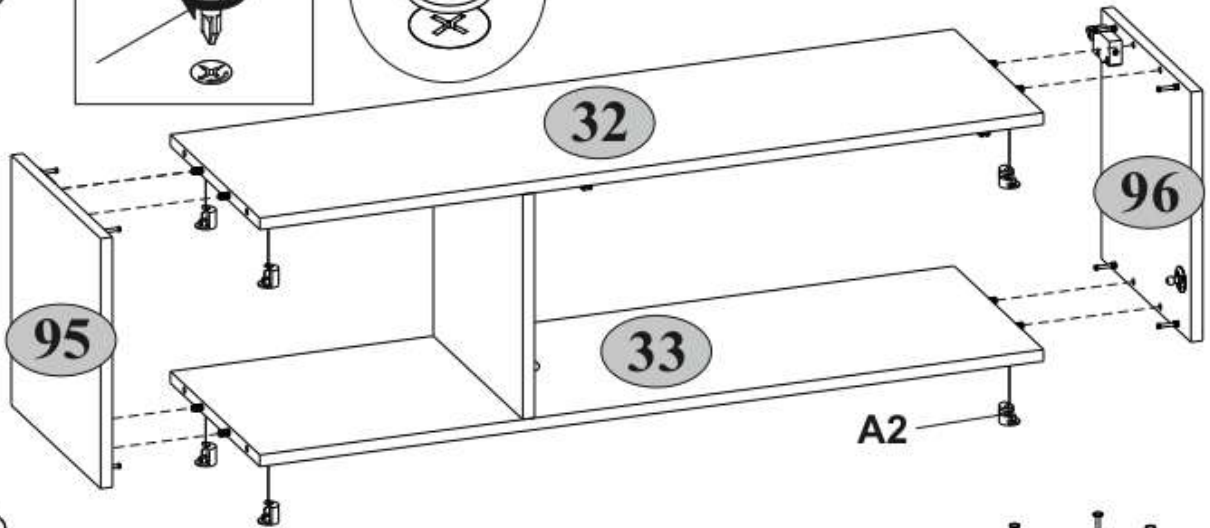
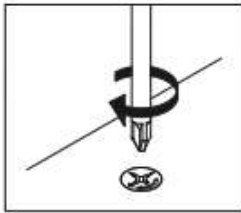

9

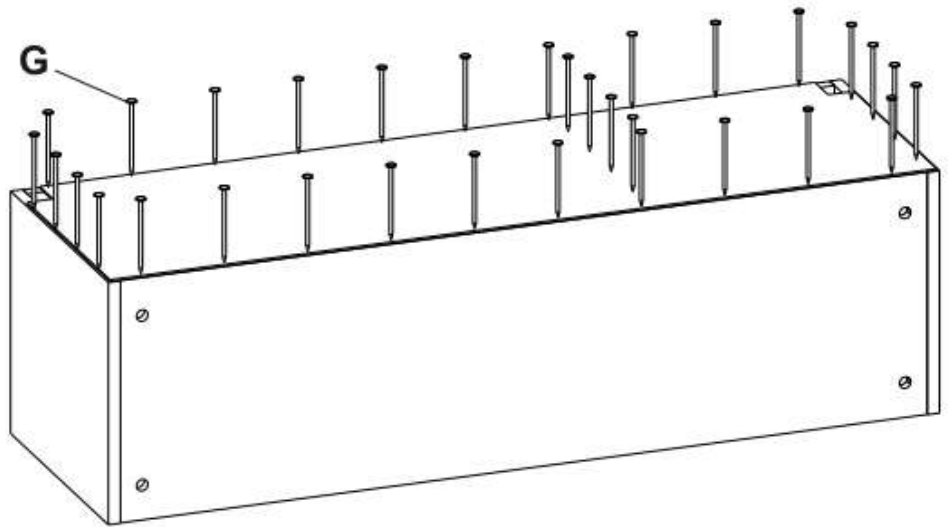
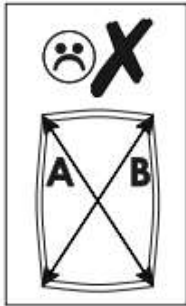
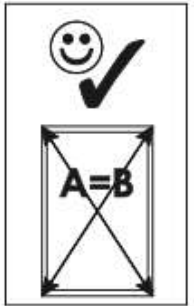

10

